

exterpark & the magnet®

Arguably best WPC decking available with two patented innovations

DECKING REINVENTED

TECH FEATURES

Competitive Advantages

Exterpark encourages to leave behind for good the bad performing double side hollow classic profile.



Tech Choice is more balanced and 20-25% more solid than most classic profiles.

The invisible profile prevents impacts of objects such as chair legs or shoe heels to be stuck between boards.

Assets

- Patented profile with invisible gap
- Patented installation system: The Magnet
- Installation with no screws
- 100% accessible
- Easy installation and maintenance
- All-weather resistant
- Termite and insect-proof
- Low surface maintenance
- Barefoot friendly

Composition

65% Reclaimed FSC Wood
30% P.E.
5% Additives



TECH CHOICE

- Exterpark Tech Choice with grooved surface.
- Patented invisible profile with no open gaps.
- Screwless installation patented magnet system.
- 100% accessible boards.

MANUFACTURING

Exterpark Tech Choice is manufactured by extrusion process featuring an asymmetrical patented profile with invisible gaps, hollow body, grooved top surface and bottom grooves for the Magnet Clips.

OFICIAL PERFORMANCE TESTS

Loading capacity (Exterpark Tech Choice + Aluminum joists+Pedestals). 4000kg
Slip Resistance. Class 3Rd>45 (best class requested for outdoor flooring and humid areas)
Wind load resistance test in accordance with ETAG 034. Suction test: 4500pa - 320km/h
Pressure test: 3000pa
Golf car test Traction and fatigue exterpark magnet

PHYSICAL AND MECHANICAL PROPERTIES

Modulus of Elasticity 36.2 Mpa
Hardness 7144 N
Tensile Strength. 21.6 Mpa
Water absorption ~2.00%
Density 1.39 gr/cm3
Coefficient of Thermal Expansion. ~0.0000114m/m °C
Abrasion Resistance ~0.15 gr
Fire resistance. C(f)-S1
Weathering Xenon Arc Exposure *2000Hrs Colour Change / Moderate Effect
Chalking / No Effect
Checking / No Effect
Cracking / No Effect
Blistering / No Effect
Flaking / No Effect
Resistance to fungus. Very Resistant



STANDARD PROFILE WITH OPEN GAPS

EXTERPARK INVISIBLE PROFILE





ASSEMBLY

easy No screws

fast No predrilling

silent No tools

COST-EFFICIENT

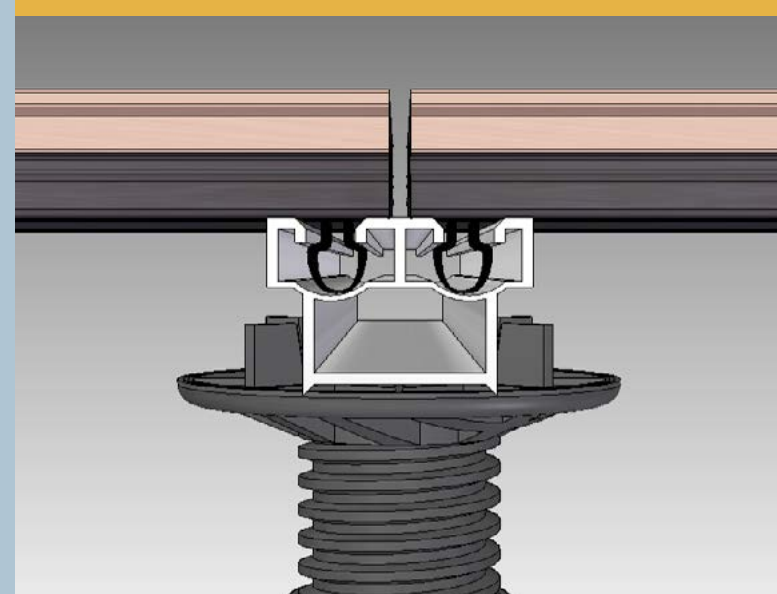

TOTAL ACCESSIBILITY

maintenance friendly

easy substitution of boards

enlarged service life

relocation possibilities

REUSABLE



PROFILE & COLOURS

DIMENSIONS: 22X145X2200 MM



Antracita

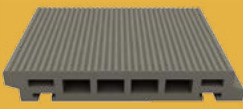

Pizarra



Tierra



Terracota



Arena



Nieve

MAGNET INSTALLATION KIT

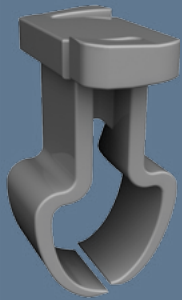
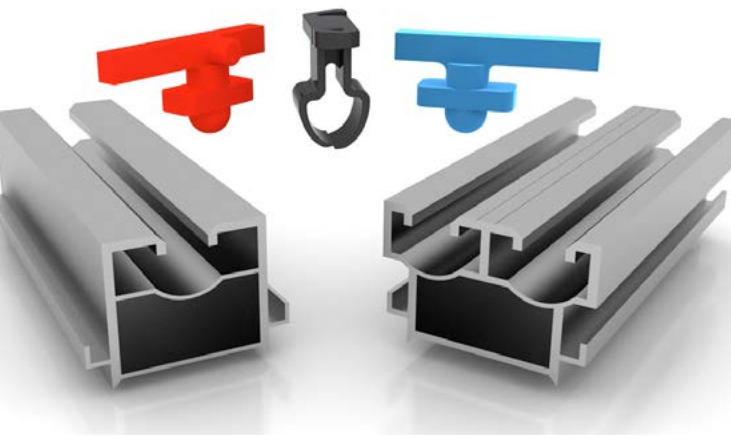

The **Magnet clip** is the corner stone of the system. The key is the strength with the right flexibility. Fully made of POM, a high performance engineering thermoplastic with excellent dimensional stability even at extreme conditions. Strong yet flexible, low friction coefficient and high abrasion resistance.

Spacer and Blocking Spacer:

Leave 4mm separation between boards for an optimum drainage. Blocking units ensure an excellent performance and prevent longitudinal misplacement.

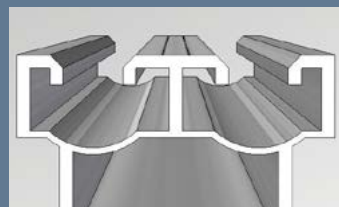
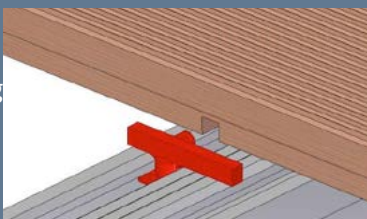

The **Double click Joist** for the short end connections is a must for the good performance of the product. It has a 4mm indicative spacing mark for the expansion gap.

L profile / Edge Board:

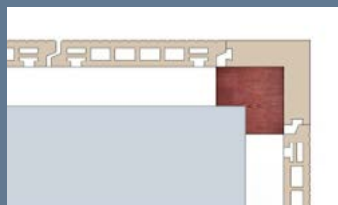

Aluminum Joists

LOW SIMPLE

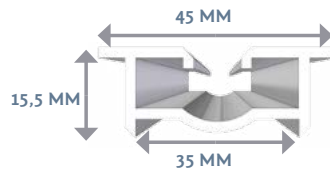

LOW DOUBLE



WALLS

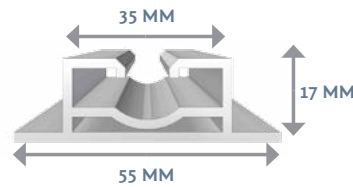

WALLS DOUBLE

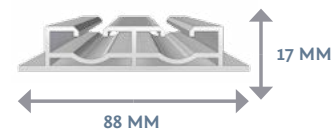

SINGLE

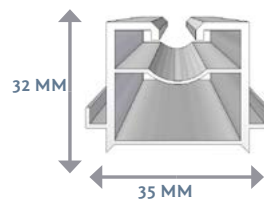

DOUBLE

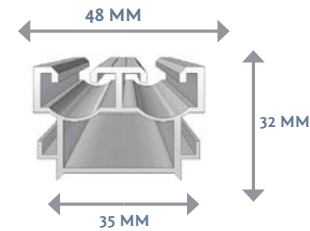

A SOLID ROCK FOUNDATION

- Improved loading capacity to more than 4000kgs/sqm
- Superior mechanical properties to hold clips
- Upgraded stability: remain straight, will not warp or decay
- Enlarged service life
- Save costs and time by using less pedestals
- Fixed lengths of 2200mm

Height-adjustable pedestals



From 5 cm up to more than 1 meter

Magnet tool

Opens boards in less than 5 seconds



Wedges

From 5 mm and up to 25 mm

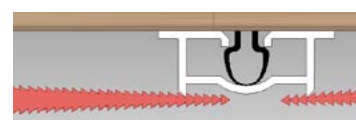

the magnet®

DECKING REINVENTED

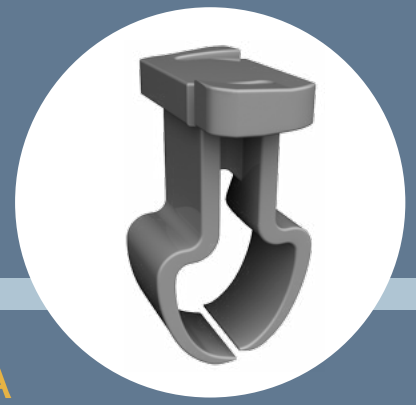

EXTREME DURABILITY

The Magnet clip is genuinely fully made of Polyoxymethylene (POM) featuring mechanical and physical properties such as high mechanical strength and rigidity, excellent fatigue and impact resistance, as well as resistance to moisture, lubricants and solvents. Essential for the performance of the clip system this material also has excellent dimensional stability, good electrical insulating characteristics, naturally resilient and self-lubricating.

Typical applications for injection-molded POM include high performance engineering components. The material is widely used in the automotive and consumer electronics industry.

FULL PERFORMANCE IN ANY ENVIRONMENT

Withstands $-40\text{ }^{\circ}\text{C}$ to $+90\text{ }^{\circ}\text{C}$
Density of $\approx 1.410\text{--}1.420\text{ g/cm}^3$.
Melting point of $178\text{ }^{\circ}\text{C}$

TECHNICAL DATA

Mechanical Properties	Value	Test Standard
Tensile modulus	2300 MPa	ISO527-1/-2
Yield stress	56 MPa	ISO527-1/-2
Yield strain	18%	ISO527-1/-2
Nominal strain at break	35%	ISO527-1/-2
Flexural modulus	2100 MPa	ISO178
Flexural stress at 3.5%	60 MPa	ISO178
Tensile creep modulus		
1 h	2300 MPa	ISO899-1
1000 h	1200 MPa	ISO899-1
Thermal Properties		
Melting temperature	178 °C	ISO11357-1/3
Temp. of deflection under load		
1.8 MPa	78 °C	ISO75-1/-2
0.45 MPa	146 °C	ISO75-1/-2
Vicat 50°C/h, 50N	140 °C	ISO306
Coef. of linear thermal expansion		
Parallel	130 E-6/K	ISO11359-1/-2
Normal	120 E-6/K	ISO11359-1/-2

CLASSIFICATION FOR OUTDOOR SUITABILITY:

F1

material meets both UV and water immersion requirements
UL 746C